

Operation Manual

Let me personally thank you for purchasing the Behmor 1600. I'm 100% positive the coffees roasted will be the freshest you've ever enjoyed. Until recently, only those in the coffee business almost exclusively enjoyed this coffee experience. The Behmor 1600 changes that. You'll quickly come to find, as I did, that roasting coffee is easy to do, will provide you immeasurable pleasure along with unparalleled coffee.

I'd also like to take a moment to tell you the Behmor 1600 has been designed and manufactured to meet the low pollution standards known as RoHS aka reduced hazardous substances. No agency has required I do this. It is my personal belief we as individuals and companies make the difference. I've also requested, that where possible, all packing material is recyclable and I urge you to recycle this material.

Thank you again and may the Behmor 1600 enable you to enjoy the coffee experience at a higher level than what you are used to.

Joseph Behm
Inventor and designer

Part 1: Introduction to the Behmor 1600

The Behmor 1600:

The Behmor 1600 is the world's first and only one-pound capacity home coffee roaster. When used with high quality beans, the Behmor 1600 utilizing patent pending smoke suppression technology roasts in virtually every application with no visible smoke up to second crack (term explained later). It is also the only home roaster in the world manufactured with a variable speed motor to facilitate proper bean rotation, plus allow for higher, more efficient cooling and chaff removal. In addition, the Behmor 1600's variable-speed fan controls allow for optimum functionality.

The Behmor 1600 will, in the overwhelming majority of cases, take up to a single pound of green coffee into second crack without emitting visible smoke. For Full City+ roasts, we recommend you reduce the quantity of the roast to ½ pound. The Behmor 1600 is not intended nor meant to roast coffee to levels known as Vienna, French, Italian or darker.

In all cases follow the safety guidelines of roasting in a well-ventilated environment and other points mentioned in the Safe Guards area.

The Behmor 1600 has been designed to allow the user the option of a quick start method or other easy-to-use programmable options to adjust roast times, roast profiles, and cooling times. Like other aspects of the roaster, the control panel is designed for ease of use. The system has designated weight allowances that coordinate and adjust to various times according to the weight entered. These times create a starting point that can be adjusted to a more precise setting by using the + / - buttons. To add even greater value and provide further options the system has been designed to afford the user the option to choose various roast profiles that can slightly alter the nuances of each coffee to better suit each individual's varying tastes or better suited for a particular bean.

Cooling is an equally important aspect of insuring the finest of end results when roasting. The Behmor 1600 is pre-programmed to immediately go into a cooling cycle once the roast cycle has been completed. It can also be controlled manually. Both cooling features utilize a uniquely designed multi-speed motor. While the cooling is taking place, the chaff tray becomes integral as the fan cools the beans and separates the chaff from the beans by pushing them into the tray for easy disposal.

The Behmor 1600 is not a set and walk away device, always stay by the roaster when it's in use.

***** Check for updates at www.behmor.com/manual.html

Part II: Coffee Roasting

About Roasting:

For those new to roasting coffee, it is in many ways easier to do than barbecuing a steak and slightly more difficult than boiling water, all because of the senses. First, you can *see* the transition of the beans going from green to brown. You can also utilize another sense, that of sound. In the case of coffee beans, Mother Nature provides a natural “pop up thermometer” *per se* via sounds of cracking at defined points in the roasting process. Lastly smell. Distinct changes in fragrances occur, as the beans progress through the various stages of roasting.

Coffee beans go through changes as the internal temperature rises. As the beans hit a light tan stage, the bean has expanded and the aroma changes from that of grassiness to that of sugars caramelizing. This is nature’s way of preparing you for what is about to occur: the first crack.

The terms first crack and second crack are terms frequently used in coffee roasting and defined as:

First Crack*: The first distinct – albeit sporadic -- sounds indicate that roasting is beginning to occur. Beans start to emit their water content via steam as sugars within the bean start to caramelize. The bean structure itself starts to change with bean expansion.

Second Crack*: The second distinct set of sounds will also be initially sporadic, but usually more pronounced than the sounds of the first crack. Beans have expanded to their largest point and in some cases tiny bits of bean will explode away from the bean. If allowed to continue into second crack the sporadic nature of cracks will then sound similar to rice cereal after milk has been added. Smoke increases dramatically at this point.

The progression from 1st crack to 2nd crack.

The first series of cracks will last somewhere between 1-1.5 minutes depending upon on bean type and quantity of beans being roasted. Think of this series of cracks as your alarm bell. Your coffee is now tan and, depending upon ones own tastes, or bean type, can be stopped from this point on.

The beans then go silent. During this period, the coffee is taking on more of its distinct flavors, darker colors, the roasting cycle can be stopped and cooling begun, depending upon one’s own tastes and bean type.

If you’ve chosen to try a darker roast you’ll then start to hear cracking sounds start up again. This is the second crack. Again, the sounds will initially be irregular. Now is when most of the greatest nuances and flavor characteristics emerge.

At this time manual cooling can be started if the timer hasn’t run down to default into cooling.

*Most excellent single origin coffees and some blends invariably show their greatest character when sent into the cooling stage at the start of or at a point just prior to the second crack.

Should you decide to allow the roast to continue into second crack, the snapping sound will become very rapid and similar to that of rice cereal. Care must be taken at this point to be ready to press the cool button, as smoke levels will rise rapidly. **If heavy smoke is seen, begin cooling immediately.**

If you do choose a darker roast, we strongly recommend you reduce the amount of coffee you are roasting to ½ pound or less. **Never roast past 10 seconds into 2nd crack. If heavy smoke is seen, begin cooling immediately.**

***** Decaffeinated coffee reaches darker stages quicker than regular coffee. Any associated times shown are for regular.**

Part III: Controls, Functions and Components

In the box you should receive:

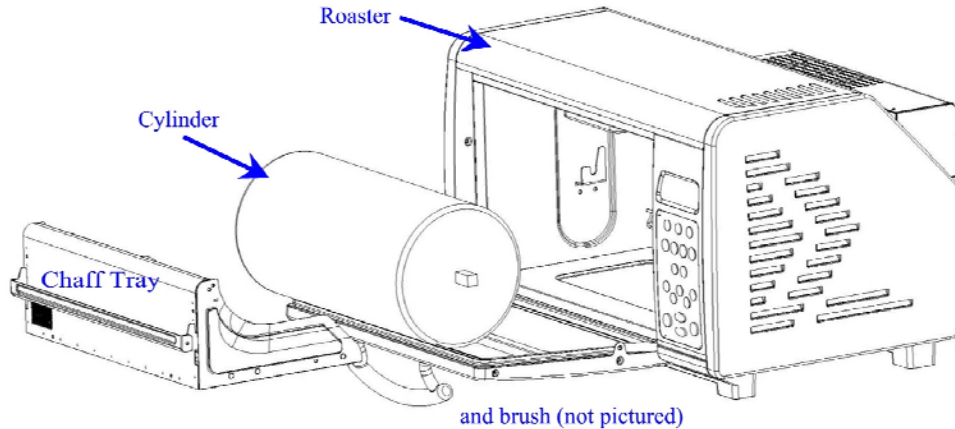

Control Panel:

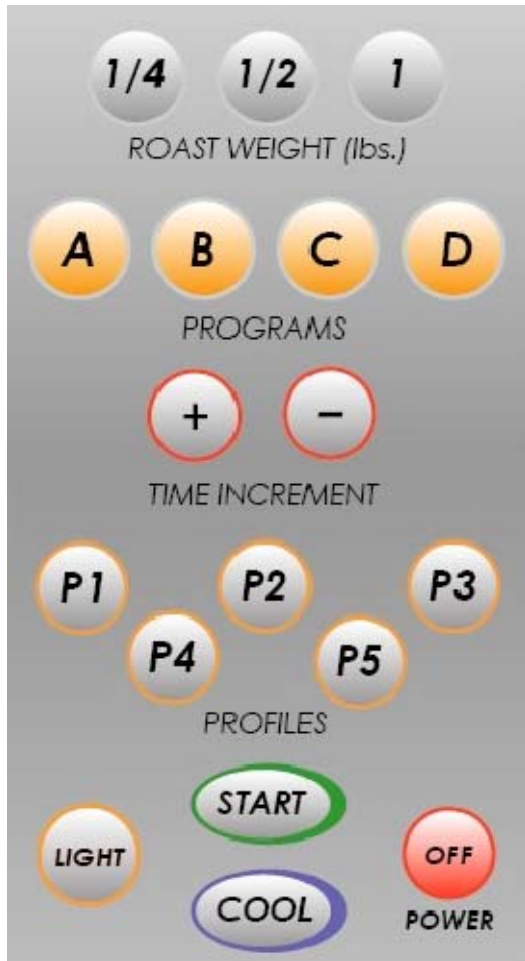

Roast Weights: Weight of green coffee beans to be roasted and system on switch. The weight buttons also act as default settings, allowing the user to “reset” the program at anytime before pressing start.

Programs/Times: System roast times directly associated with the weight chosen. See Tips and Maintenance for more complete information related to these examples.

Time Increments: Add or subtract time to/from the roast programs prior to start or at any point during roast cycle. Pressing “+” adds 15 seconds, “-” subtracts 10 seconds.

Profiles: Denote how heat is applied to the beans. P1 is the highest heat application, thus fastest roast time. P5 is the lowest overall heat application, thus slowest roast time. See Diagram of Profiles for details on heat applications along with Tips Section for more details.

Start: Starts the roasting cycle.

Cool: Allows the user to stop a roast at any time and begin cooling the beans,

Light: Light switch for viewing beans

OFF: Ceases all system functions. DO NOT press OFF during the roast cycle **except** in an emergency situation (such as fire). Pressing OFF before the roast cycle is complete could lead to excessive smoke and possibly create a fire hazard.

Part III: Controls, Functions and Components Continued

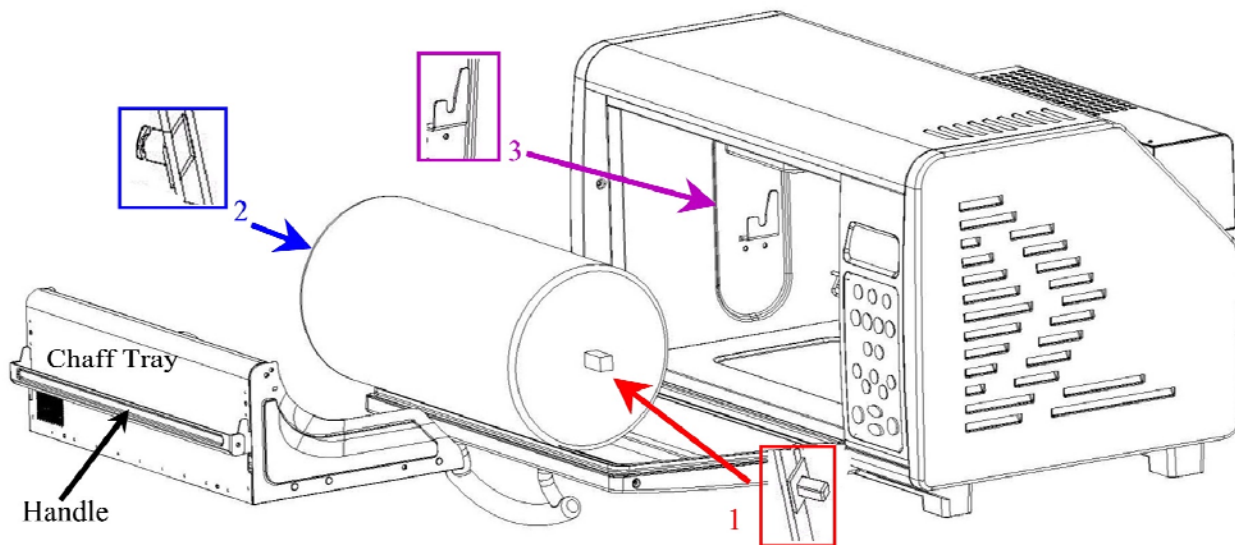

Cylinder: The cylinder (see above) has been designed for ease of use. One end has a square peg (red arrow- #1), which can only fit into the motor drive (inside right-not shown), with the left end having a grooved round peg (blue arrow- #2) whose groove drops into the holder's (purple arrow- #3) slot.

Chaff Tray: Collects chaff that falls from the cylinder or pushed into the tray by the cooling fan. The tray can also be used as a "dust pan". Remove the tray; remove the cylinder, then using the brush sweep the remaining chaff into a pile. Place the tray at the lip of the roasting chamber and using the brush, sweep the remaining chaff into the tray.

Roast Cycle: The system has been designed to read the data input (weight, time, etc.) and adjust system functions accordingly. The initial start times are the basis for the Profiles but times can be adjusted up (+ equals 15 seconds added) or down (- equals 10 seconds subtracted) at any time prior to start or during the roast. When the roast time has reached 59 seconds remaining, the digital display will blink on and off alerting you to time remaining until roast completion. If you desire to add time, you can do so up until a display time of 00:01. If you allow the system to go to 00:00, it will automatically go into its pre-programmed cooling cycle. **WHEN THE SYSTEM GOES INTO COOLING DO NOT RESTART THE ROAST CYCLE. DOING SO WILL CREATE TREMENDOUS AMOUNTS OF SMOKE AND POSSIBLY CREATE OTHER HAZARDS.**

Cooling Cycle: The system has two cooling cycle programs. One is an automatic cooling cycle that starts once the roasting timer goes to 00:00. When cooling begins, the display will show the countdown time for cooling. There is also a manual cooling cycle option available to the user. Should you decide at any time to end a roast, simply press the cool button and roasting will cease and cooling will begin. As with automatic cooling, the system timer will reset and show a new countdown for the cooling cycle.

Each system's function has been designed for a reason. It is imperative you allow the system to perform as designed for optimal performance and longevity. This is especially true of the cooling cycle. Failure to comply with these recommendations or those listed in the Important Safeguards could result in a potential safety hazard.

If you do not understand a function or parts of the system, email us at tech@behmor.com and we will do our best to answer any/all questions you might have. Please include a phone number so we can, if necessary call to better communicate an answer to you.



Part IV: System Preparation, Start-up and Programming

System Check:

To insure all functions are working properly press each button within each group in the following order: Press all Weight buttons starting with ¼, ½, to 1 noting time in the display changes. Next, Profiles starting with P1 through P5, noting changes on the display. Next, Programs A through D, again noting display changes. Next press, each (+ then -) Increments, Light, Cool, then lastly OFF. Start will be tested in the next step.

Preparing the Behmor 1600 for Use:

Before first use, clean the interior of the roasting chamber with a moist cloth. At the same time check the cylinder, oven chamber and all areas of the chaff tray for stray packing material. If found remove. Then, insert the cylinder and chaff tray in their proper locations and close the door.

Press  

This procedure, also referred to as a dry burn, is necessary to help eliminate any residue left in the roaster during the manufacturing process while also serving to “season” the roaster and door gasket. During the first few roasts you may see some very faint smoke from the exhaust or gasket area but this should cease as the system self cleans, seasons and fine-tunes itself. This same procedure is used for periodic system self-cleaning coupled with Simple Green, as described later in the Tips and Maintenance section.

Getting Started:

Take the roasting cylinder and insert the desired amount* of green coffee beans, close the cylinder, making sure the cylinder clasp is securely in place.

Next, with cylinder in hand, carefully place the cylinder into the roasting chamber as shown previously, inserting the right end (square peg) into the motor drive while laying the left end (round peg w/groove) onto the holder. You may find the square peg might require slight rotation of the cylinder for it to slide fully into place. You’ll know it is in place when the left (round) side’s groove drops into the holder’s cut away. **Always double-check to insure the cylinder is properly in place.**

Install the chaff tray by gently depressing the spring loaded handle downward, slide it into the roasting chamber until it goes no further, release the handle. Improper placement can prevent the cylinder from rotating properly, causing the cylinder to jam. (see Chaff Tray Instructions for further details)

Close the roaster door ensuring the door is closed tightly.



*** Whether new to, or experienced with roasting coffee, we strongly suggest you start off by roasting several ¼ pound batches to begin developing an understanding of the subtle nuances of roasting coffee with the Behmor, the snaps described earlier, and the aromas associated with these snaps. We also suggest to always forward think your roast by 10 seconds. Following this suggestion will lead to a greater enjoyment later.**

Reminders

- 1) You are in control of the roaster so never leave the roaster unattended when roasting coffee. The Behmor 1600 is not a set and walk away device.
- 2) Always roast in a well-ventilated area.
- 3) Never roast past 10 seconds into 2nd crack.
- 4) You can add or subtract time at any point prior starting a roast or during a roast adding up to the maximum times allowed. (see Part V Paragraph 6)
- 5) You can end a roast at any time by pressing the cool button.
- 6) Times between start of 1st crack and 2nd are shown in Part V Paragraph 3. Use this chart to better understand where you are in a roast. This helps to prevent over roasting your beans
- 7) If at any time prior to start you make a mistake. Hit your appropriate weight and everything resets to the start/default point.
- 8) Allow 1 hour between roasts
- 9) Always gauge degree of roast by sight, sound and/or aroma- not by the presence of oils. Oils appear after coffee is allowed to rest

Part IV: System Preparation, Start-up and Programming continued

Quick Start Default P1- Hard Bean

Weight - Profile	Press in following order	Start Time / Max Time**
¼ Pound roast - P1 (default)		8:30 / 10:00
½ Pound roast - P1 (default) * Also used for system self-clean/dry burn		12:00 / 13:30
1 Pound roast - P1 (default)		18:00 / 20:30

Profile P2 - Hard Bean

¼ Pound roast – P2		9:30 / 10:30
½ Pound roast – P2		13:00 / 14:30
1 Pound roast – P2		20:00 / 22:30

Profile P3 – Soft bean/low grown/ espresso blends

¼ Pound roast – P3		10:00 / 11:00
½ Pound roast – P3		14:00 / 15:30
1 Pound roast – P3		21:30 / 23:30

Profile P4 – Soft bean/ low grown or espresso blends

¼ Pound roast – P4		10:20 / 11:30
½ Pound roast – P4		14:40 / 16:30
1 Pound roast – P4		22:40 / 24:30

Roasting times will vary according to actual in home voltage. P4 and P5 times shown have been adjusted to match in home times to 2nd crack. See further data in Tips and Maintenance on voltage/ time issues.

* System self clean/dry burn as explained in Tips and Maintenance Section

**Maximum Times denote the maximum allowed roast time per pre-set profile and weight. This feature is meant to limit over roasting the coffee beans. See further data in Tips and Maintenance.

Part IV: System Preparation, Start-up and Programming continued

Profile P5- Hawaiian/ Island Coffees- City/City+

Weight - Profile	Press in following order	Start Time / Max Time*
¼ Pound roast – P5		10:45 / 12:30
½ Pound roast – P5		15:30 / 17:30
1 Pound roast – P5		23:30 / 25:30

Roasting times will vary according to actual in home voltage. P4 and P5 times shown have been adjusted to match in home times to 2nd crack. See further data in Tips and Maintenance on voltage/ time issues.

****Maximum Times denote the maximum allowed roast time per pre-set profile and weight. This feature is meant to limit over roasting the coffee beans. See further data in Tips and Maintenance.**

Part V: Tips, Maintenance, FAQs and Troubleshooting:

Tips and Maintenance

- Always [forward think your roast](#) by 10-15 seconds. This is the amount of time that is required to start reversing the trend from roasting to cooling.
- [After five roasts cycles, always perform a system self clean.](#) Insert the cylinder (empty), chaff tray, close the front door, press ½ then Start. Let the system complete an entire roast & cool cycle. We also suggest a quick clean with Simple Green as well by *lightly* spraying the top/ side walls (avoid the back elements) then wipe clean. Failure to perform these maintenance procedures will in time adversely affect your roaster's functionality and longevity.
- The following times listed are [guidelines to better anticipate a roast hitting 2nd crack](#). The times shown are approximately what it takes from start of the first crack/snap of 1st crack to the start of 2nd crack for regular coffee ([decaf gets darker quicker](#)). This guideline is especially important to know when using Profile 2/ P2. We have found over the course of many tests using P2 it will give you only a few 1st cracks then go silent, moving gently into 2nd crack in the times shown below. We suggest adjusting times as close to the following once you hear the first cracking sound of 1st crack. This should allow you to more accurately control your roast.
 - ¼ lb - 1:30 minutes
 - ½ lb - 2:10 minutes
 - 1 lb- 3:10 minutes
- Roasting times may vary due to voltage, but a good understanding of the A, B, C, D (Program /Times) to Profiles P1, P2, etc., is as follows:
 - A to P1
 - B to P2
 - C to P3
 - D to P4 (subtract 30 seconds using)
 - D to P5 (add 30 seconds using)
- Associated [initial start times](#) of A, B, C, D to weights ¼ , ½ , 1 (see Chart on next to last page)

	¼	½	1
A	8:30	12:00	18:00
B	9:30	13:00	20:00
C	10:00	14:00	21:30
D	10:30	15:00	23:00

Part V: Tips, Maintenance, FAQs and Troubleshooting continued:

- 6) In order to prevent possible issues with over roasting, we have built in [maximum roast times associated with each profile](#). If you should happen to be roasting at P1, the system is designed to prevent you from allotting more than 20:30 minutes roast time. This is a safety feature. The same feature is true for the other profiles but with longer times. See Chart below:

	1/4	1/2	1
P1	10	13:30	20:30
P2	10:30	14:30	22:30
P3	11	15:30	23:30
P4	11:30	16:30	24:30
P5	12:30	17:30	25:30

* When using P1 or P2, in certain instances, Program times C and/or D, may appear not to function. This was designed to occur. In those instances C and/or D's pre-programmed start times exceed the maximum allowed roast time for that profile.

- 7) For [quicker cool down](#) an option does exist, should the user decide take the following measure. After the beans have ceased snapping (approximately 1:30), while keeping the system on cool, simply open the front door. Doing this will facilitate a greater airflow over the beans. The one drawback is small amount of chaff will find it's way past the chaff tray.

NEVER STOP THE SYSTEM IMMEDIATELY AFTER COMPLETING A ROAST TO REMOVE THE CYLINDER AND COOL THE BEANS. DOING A SYSTEM STOP BEFORE REASONABLE COOLING COULD DAMAGE THE SYSTEM'S INTERNAL ELECTRONIC COMPONENTS.

- 8) Hard bean (SHB- strictly hard bean or HG- high grown) v soft bean is based on the altitude beans are grown at. Bean suppliers often post data about grades, such as SHB, HG etc when describing the bean characteristics.

For me personally my standard choices are:

- P1-2 All centrals, Peruvian and Colombians
- P3... Brazilians, Africans, SE Asians, Malabar, Jamaican Blue Mtn and Yauco Selecto (Puerto Rican)
- P4-5 Kona and other low grown island coffees

Part V: Tips, Maintenance, FAQs and Troubleshooting continued

<p>My system stopped and an error message reads:</p> <ol style="list-style-type: none"> 1) Err1 2) Err2 & Err3 3) Err4 4) Err5 5) Err6 	<ol style="list-style-type: none"> 1) Thermostat is damaged or systems has been stored in cold environments 2) Coffee beans have burned or the oven chamber has experienced an unacceptable rise in heat 3) Draw fan is damaged 4) DC fan is damaged 5) DC motor (cylinder) is blocked or damaged. 	<p style="text-align: center;"><u>If an error message appears, immediately cease using the Behmor.</u></p> <p style="text-align: center;"><u>Then visit our website's tech pages for solutions and ways to contact tech support.</u> http://www.behmor.com/tech_support.html</p> <p>always check for Updates on our web site</p>
<p>In cooling I noticed a little smoke leakage</p>	<p>We have worked to seal the door area and other tiny cracks, but to totally seal the system is impossible. On rare occasions, wisps of smoke may appear</p>	<p>We advise gently cleaning the door seal on a regular basis with a damp cloth to ensure no chaff or other particulate matter prevents a proper seal.</p>
<p>When roasting, I noticed a little smoke from the exhaust.</p>	<ol style="list-style-type: none"> 1) Occasionally, whether due to the quality of the beans, the darkness of the roast or even the quantity/darkness of the roast, small amounts of smoke may be seen. 2) During the first couple of roasts there may be a little smoke as the system “seasons” itself. 3) Home wiring could be old and doesn’t supply a sufficient amount of voltage to run the system properly. 	<ol style="list-style-type: none"> 1) reduce the quantity of that type of bean when it is noticed it tends to smoke. 2) On subsequent roasts the smoke should go away. 3) Try different power outlet whose line may carry a greater amount of voltage
<p>Sometimes I notice, even when I’ve added time I can’t complete a roast to a desired degree.</p>	<p>In some instances and in some homes there will and can be voltage issues that are outside our control.</p> <p>In other instances sediment has been allowed to build up and the interior needs cleaning with Simple Green. See also Updates 1-3 on the website</p>	<ol style="list-style-type: none"> 1) Try using a different outlet. In some cases an outlet only a matter of a few feet away can and will have better voltage input and sustainability. 2) Try roasting at a different time of day. As is true throughout the country during summer the afternoons are when the largest power consumption occurs
<p>I tried the above and I still have the same problem.</p>	<p>In older homes where the wiring goes back to the copper clad aluminum days or further back where you have consistently low voltage.</p>	<ol style="list-style-type: none"> 1) If wanting to roast the maximum we suggest reducing the quantity from 16 ounces to 13-14 ounces yet still using the 1 pound programs. 2) If you want to roast using ½ pound setting with either profiles (P2-5) we suggest using 6 ounces of green coffee.
<p>While the chamber was still warm I opened the front door and noticed the <u>gasket is wavy in appearance.</u></p>	<p>The gasket is attached using tiny nipples and not glued so the expansion and contraction caused by heat up and cool down has no ill effects on the materials</p>	<p><u>Do nothing</u> this has been designed to be as it is.</p>
<p>When the cylinder is turning I hear squeaking.</p>	<p>Like any metal to metal rubbing, in time noises can be emitted.</p>	<p>Take a Q Tip or similar, place a drop of <u>food oil</u> (olive, veg etc.) on it. Now rub the Q Tip in the grooved area (round peg) of the cylinder</p>

Part V: Tips, Maintenance, FAQs and Troubleshooting continued

Only use the Behmor 1600 a well-ventilated environment and maintain at least 18”(eighteen inches) of clearance on all sides, this includes 18” clearance from the top and exhaust the vent.

In Case of Fire: Never open the chamber door.

The Behmor 1600 should automatically react to a bean ignition and shut down. Once the system has performed a shutdown, unplug the roaster and, if possible, move it outdoors for proper venting. Causes of such an ignition would likely be traced back to using a high chaff coffee or allowing a roast to go past 10 seconds into 2nd crack. As instructed earlier, we strongly advise against the use of high chaff producing coffees or roasting past 10 seconds into 2nd crack .

If the system should not shut down because of fire, as instructed earlier in the Important Safeguards, stop the roast and unplug the roaster. Then move it outdoors when safe to do so.

AGAIN NEVER open the chamber door if a fire occurs.

For any other problems, please email tech support- tech@behmor.com. Please tell us what you were doing, where you were in the roasting process-as best you can, and identify the issue as much as possible. Please also include phone number or other contact information so customer service can respond.

Online registration: www.behmor.com

Manual updates: www.behmor.com/manual.com

Be sure to include you email address to receive any updates regarding manual changes, special promotions or other items.

REMEMBER

The Behmor 1600 is not a set and walk away device.

You are in control of the roaster thus never leave the roaster unattended when it is in use.

Preset times/ programs are merely estimates and manual cool buttons are provided so the user can cease the roast at any time.

Weight (1/4, 1/2 , 1) to Program (A,B,C,D) Roast Times*

1/4 LB ROASTS

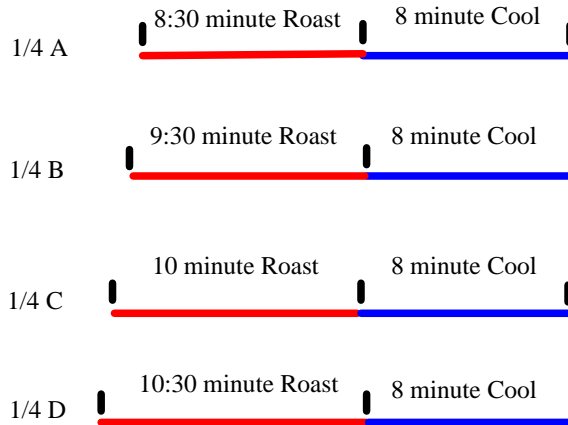

1/2 LB ROASTS

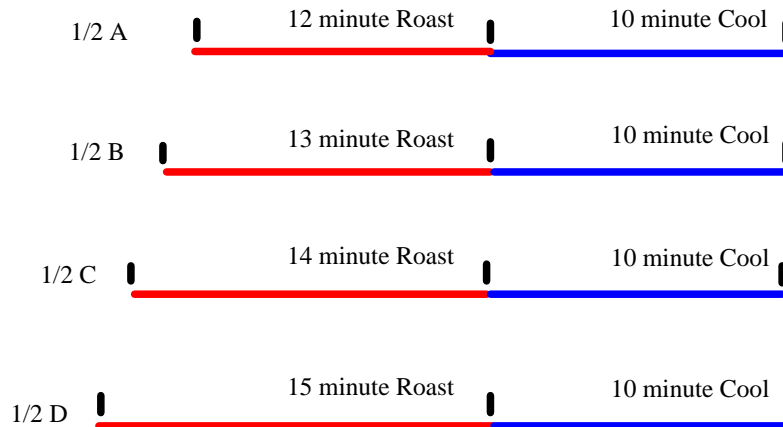

1 LB ROASTS

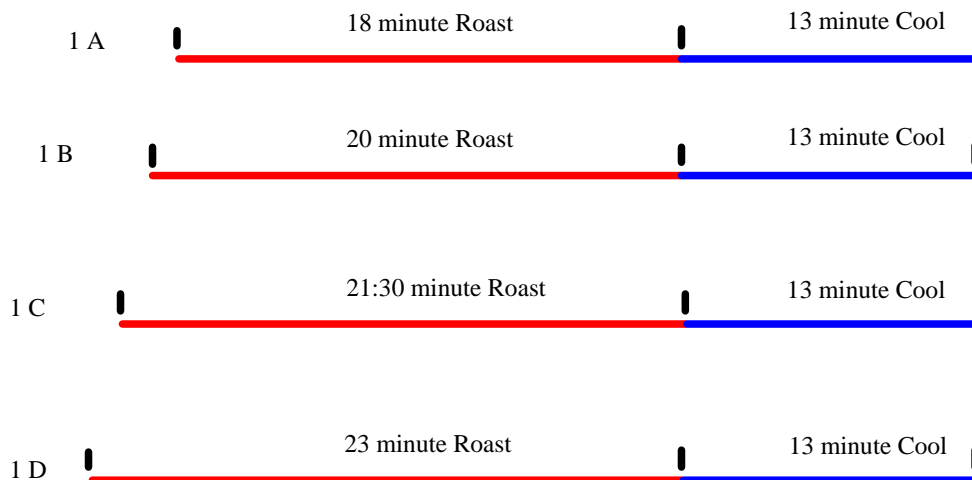

*all roast times shown are pre-programmed defaults prior to any user's optional adjustments

Roast Profiles/Heat Applications

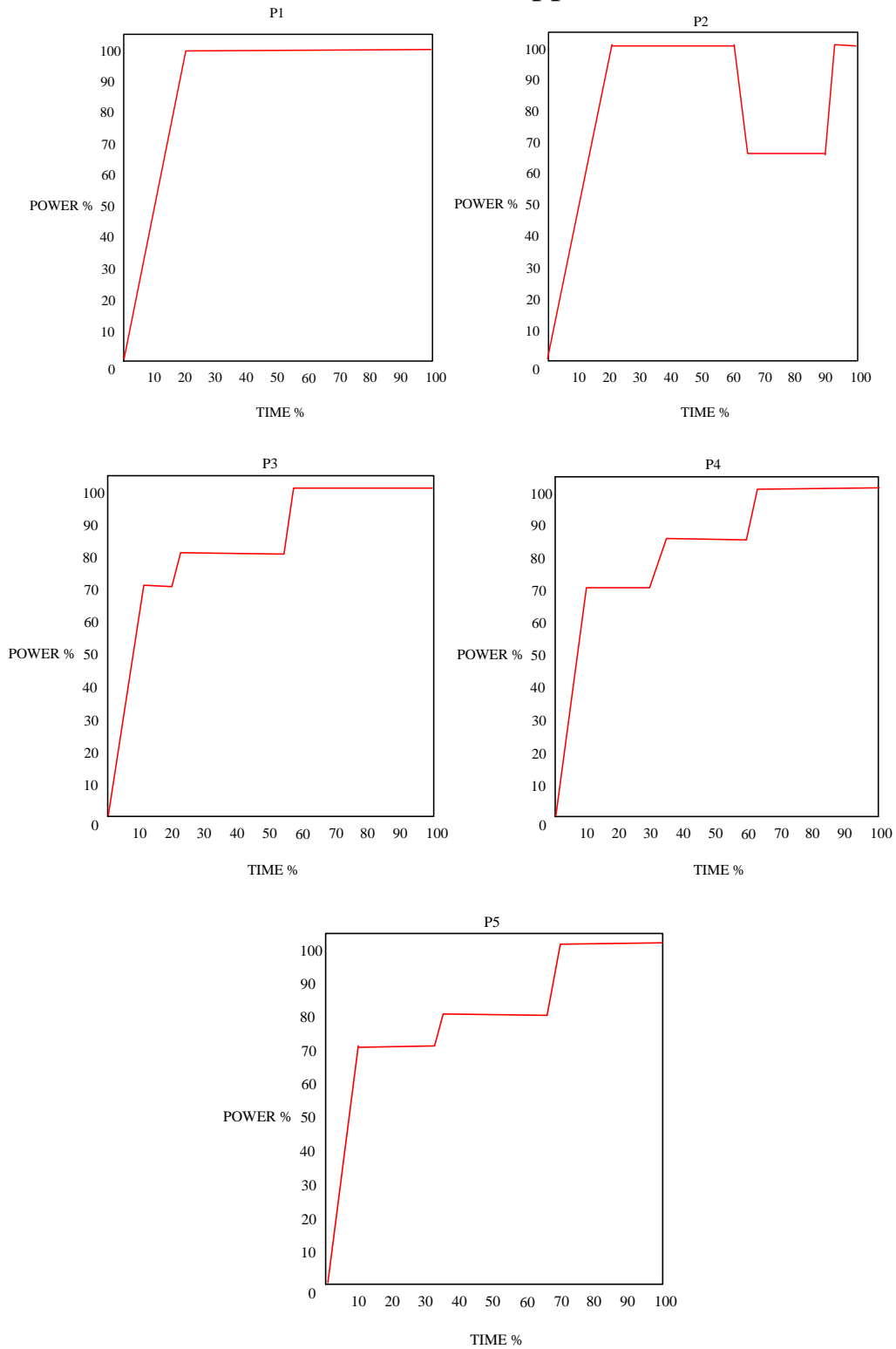

**** above profile data is for illustrative purposes only and intended to solely provide basic concepts of how the system is intended to function under normal conditions.**

Roasting Log

Bean Type / Weight	Total Time	Profile/ Roast Type	Comments

Limited Warranty

The Behmor 1600

12 month Limited Warranty: Behmor Inc., warrants to the owner of this product that it is free from defects in material and workmanship for a period of 12 months from date of purchase providing the Owner Registration Card has been completed and returned to Behmor Inc., within thirty (30) days from the original purchase date or Owner Registration at www.behmor.com has been completed online within (30) days from the original purchase date.

The manufacturer's obligation will be limited to repairing or replacing F.O.B. (address city state zip) any part(s) of the product which is/are defective.

Such warranty will not apply to defects resulting from commercial use, tampering, cosmetic damage, acts of God, accidental breakage, abuse, negligence, neglect, and/ or misuse.

If the product is defective within the **FIRST 30 days** of the purchase date, please contact Behmor Inc. and they will provide you with a return label, a return authorization and/or send you a new part(s) to replace the defective one(s).

If you must return the product for reasons of malfunction **after the first 30 days but within the 12-month** warranty period, the following action and steps are required:

1. The machine must be packaged securely to protect from damage or breakage in shipment. Behmor Inc. accepts no responsibility for damages occurring in the shipping process. We highly recommend insuring the shipment in case the shipping firm damages the roaster.
2. Email or call Behmor Inc. to obtain a Return Merchandise Authorization (RMA). Then ship prepaid to Behmor Inc., by the most convenient method with the RMA clearly noted on the outside of the box.
3. If you return the product after the 12-month warranty period, enclose \$189.00 plus \$25 in US Dollars, for shipping, handling and insurance and Behmor Inc. will replace/repair your machine and return it to you.

Even if not required, the rights in this warranty are granted to you. This warranty gives you specific legal rights, and you may also have other rights, that could vary from state to state. Return of Owner Registration Card is not a condition precedent to warranty coverage.

Behmor Inc., will not be held liable for any special, incidental, or consequential damage, resulting from possession, use, or loss of use of this product either directly or indirectly.

No returns will be accepted without prior authorization and company issued RMA number.

To receive a Return Merchandise Authorization (RMA) email Customer Service at tech@behmor.com for RMA instructions

Date of Purchase _____ **Serial Number** _____

The Behmor 1600 is intended for personal/household use only.

The Behmor 1600 is not intended to be used commercially or in any commercial setting. Any commercial usage or attempted commercial usage automatically voids any and all warranties.

Important Safeguards

When using ANY electrical appliance(s), basic safety precautions should always be followed, and are the sole responsibility of the user/owner, including the following:

1. Never leave The Behmor 1600 unattended when in use. User must always have the chaff collection tray and the roaster cylinder in place when roasting.
2. Always operate The Behmor 1600 in a properly ventilated environment and positioned where no objects or obstructions of any kind, including cabinets, can in anyway impede, obstruct or cover the exhaust outlets. The exhaust outlets should always have a minimum of 18” inches (46cm) clearance above and around.
3. Never roast coffee past 10 seconds into 2nd crack. If you see heavy smoke immediately cool the roast.
4. Do not use any attachment(s), and/or item(s) that is or are not approved by Behmor Inc. in or on, The Behmor 1600. Using such items is strictly prohibited and will automatically void all warranties.
5. Do not use high chaff green un-roasted coffee. The use of such items may cause the roaster’s functions such as the smoke suppression feature, safety features and roast times to be negatively effected. We recommend you use only reputable bean suppliers or those on our approved bean supplier list.
6. Do not touch hot surfaces. This includes: Front door, top, back, exhaust, exhaust covers and sides of The Behmor 1600. Always use adequate oven mitts or gloves when handling hot surfaces.
7. ADULT supervision is absolutely necessary and the responsibility of the user(s)/owner(s) when The Behmor 1600 is being operated near children or in households with children present.
8. Unplug The Behmor 1600 from the outlet when not in use and NEVER operate The Behmor 1600 with a damaged cord or plug. Do not immerse cord, plug or The Behmor 1600 itself in water or other liquids. To disconnect The Behmor 1600 must not be running, then properly/firmly grip the plug and pull from wall outlet. Do not pull or tug on the power cord.
9. If you see fire, turn off and unplug The Behmor 1600. Do not open the door until it has cooled down. This is an electrical appliance, never put water in it, or on it, to cool it down or stop it.
10. Do not use outdoors and do not use with extension cords. As with any appliance the use of extension cords could adversely affect roaster functions and dramatically extend roast times.
11. Do not place The Behmor 1600, on or near hot gas and/or electric burners, in a heated oven or in close proximity to easily flammable material.
12. Use only on a stable, heat-resistant surface. Place The Behmor 1600 at least 18” inches (46cm) from ALL walls or cabinets and have at least 18” inches (46cm) clearance above unit.
13. Use extreme caution when working near the hot surfaces and the heating elements as these parts become and can remain very hot. Also use maximum care when removing the chaff tray as it too can and does become very hot.
14. It is the user’s responsibility to be 100% sure all connections are secure and that all doors, latches to the roasting cylinder, and door to the roasting chamber have all been closed/secured properly before any use.
15. Never open The Behmor 1600’s front door when roasting elements are on.
16. Do not clean the interior with any metal cleaning pad or any cleaning solvents containing caustic chemicals or abrasives. Simple Green is our recommended cleaner.
17. Do not use The Behmor 1600 for anything other than its intended use.

18. Never exceed recommended maximum roast capacity of 1 pound, also known as, either/or 16 ounces or 454 grams.
19. Do not allow contact with any objects. A fire may occur if The Behmor 1600 is covered or is touching flammable material, including curtain, draperies, walls, and the like, when in operation.
20. Do not place, or store, any objects or material other than items supplied by Behmor Inc. such as the roasting cylinder and chaff tray on or in The Behmor 1600.
21. Unplug The Behmor 1600 before changing/replacing the interior light bulb.
22. The Behmor 1600 comes equipped with a polarized plug (one prong is wider than the other) that will fit only one way in a polarized outlet. If the plug does not fit the outlet properly, turn the plug the other way; if it still does not fit, contact a qualified electrician for assistance.

DO NOT ATTEMPT TO ALTER THIS SAFETY FEATURE OR ANY FEATURE OF THE Behmor 1600. To do so voids all explicit and implied warranties /guarantees and relieves Behmor Inc. of any/all liabilities arising from such misuse and tampering

Remember:

Never leave The Behmor 1600 unattended when in use.

Always use in a well-ventilated environment and maintain a minimum of 18”(eighteen inches or 46 cm) of clearance on all sides, top and from the exhaust vent.